

TASHAN

HIGH PERFORMANCE MONOCRYSTALLINE PERC MODULE

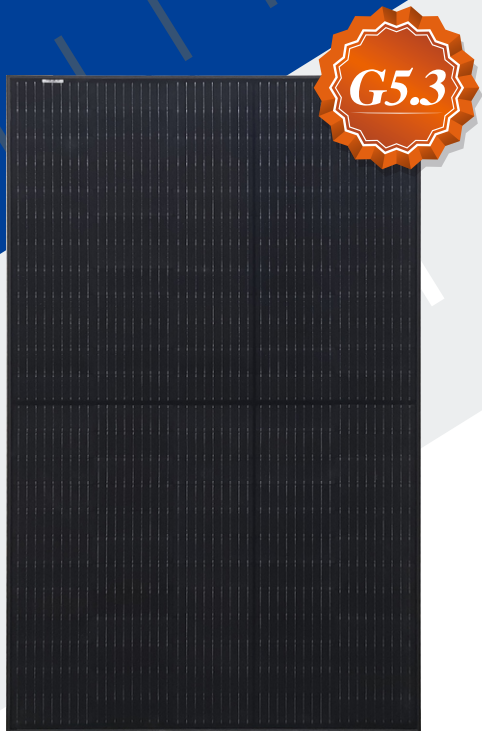

RSM40-8-385MB-405MB

120 CELL Mono PERC Module	385-405Wp Power Output Range
1500VDC Maximum System Voltage	21.1% Maximum Efficiency

KEY SALIENT FEATURES

- Global, Tier 1 bankable brand, with independently certified state-of-the-art automated manufacturing
- Industry leading lowest thermal co-efficient of power
- Industry leading 25 years product warranty
- Excellent low irradiance performance
- Excellent PID resistance
- Positive tight power tolerance
- Dual stage 100% EL Inspection warranting defect-free product
- Module Imp binning radically reduces string mismatch losses
- Excellent wind load 2400Pa & snow load 5400Pa under certain installation method
- Comprehensive product and system certification
 - ◆ IEC61215:2016; IEC61730-1/-2:2016;
 - ◆ ISO 9001:2015 Quality Management System
 - ◆ ISO 14001:2015 Environmental Management System
 - ◆ ISO 45001:2018 Occupational Health and Safety Management System



* As there are different certification requirements in different markets, please contact your local Risen Energy sales representative for the specific certificates applicable to the products in the region in which the products are to be used.

RISEN ENERGY CO., LTD.

Risen Energy is a leading, global tier 1 manufacturer of high-performance solar photovoltaic products and provider of total business solutions for residential, commercial and utility-scale power generation. The company, founded in 1986, and publicly listed in 2010, compels value generation for its chosen global customers. Techno-commercial innovation, underpinned by consummate quality and support, encircle Risen Energy's total Solar PV business solutions which are among the most powerful and cost-effective in the industry. With local market presence and strong financial bankability status, we are committed, and able, to building strategic, mutually beneficial collaborations with our partners, as together we capitalise on the rising value of green energy.

Tashan Industry Zone, Meilin, Ninghai 315609, Ningbo | PRC
 Tel: +86-574-59953239 Fax: +86-574-59953599
 E-mail: marketing@risenenergy.com Website: www.risenenergy.com



LINEAR PERFORMANCE WARRANTY

25 year Product Warranty / 25 year Linear Power Warranty

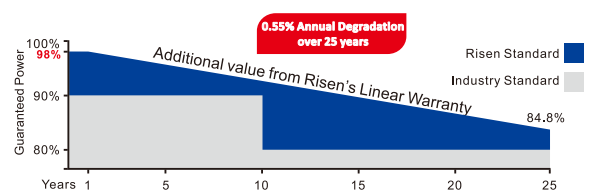

Only available from Hummingbird Group in New Zealand

Dimensions of PV Module Unit: mm

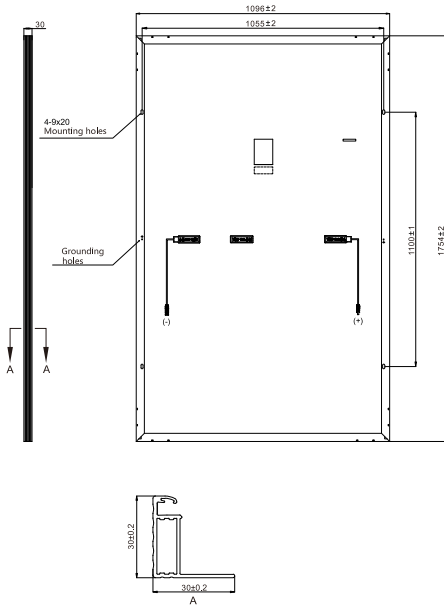

ELECTRICAL DATA (STC)

Model Number	RSM40-8-385MB	RSM40-8-390MB	RSM40-8-395MB	RSM40-8-400MB	RSM40-8-405MB
Rated Power in Watts-Pmax(Wp)	385	390	395	400	405
Open Circuit Voltage-Voc(V)	40.38	40.69	41.00	41.30	41.60
Short Circuit Current-Isc(A)	12.15	12.21	12.27	12.34	12.40
Maximum Power Voltage-Vmpp(V)	33.62	33.88	34.14	34.39	34.64
Maximum Power Current-Impp(A)	11.46	11.52	11.58	11.64	11.70
Module Efficiency (%) *	20.0	20.3	20.5	20.8	21.1

STC: Irradiance 1000 W/m², Cell Temperature 25°C, Air Mass AM1.5 according to EN 60904-3.

* Module Efficiency (%): Round-off to the nearest number

ELECTRICAL DATA (NMOT)

Model Number	RSM40-8-385MB	RSM40-8-390MB	RSM40-8-395MB	RSM40-8-400MB	RSM40-8-405MB
Maximum Power-Pmax (Wp)	291.8	295.6	299.4	303.1	306.9
Open Circuit Voltage-Voc (V)	37.55	37.84	38.13	38.41	38.69
Short Circuit Current-Isc (A)	9.96	10.01	10.07	10.12	10.17
Maximum Power Voltage-Vmpp (V)	31.20	31.44	31.68	31.91	32.15
Maximum Power Current-Impp (A)	9.35	9.40	9.45	9.50	9.55

NMOT: Irradiance at 800 W/m², Ambient Temperature 20°C, Wind Speed 1 m/s.

MECHANICAL DATA

Solar cells	Monocrystalline
Cell configuration	120 cells (5×12+5×12)
Module dimensions	1754×1096×30mm
Weight	21kg
Superstrate	High Transmission, Low Iron, Tempered ARC Glass
Substrate	Back-sheet (Front side: Black, Back side: White)
Frame	Anodized Aluminium Alloy type 6005-2T6, Black
J-Box	Potted, IP68, 1500VDC, 3 Schottky bypass diodes
Cables	4.0mm ² (12AWG), Positive(+)/350mm, Negative(-)/350mm (Connector Included)
Connector	EVO2 or Risen Twinsel MC4 Compatible, IP68

TEMPERATURE & MAXIMUM RATINGS

Nominal Module Operating Temperature (NMOT)	44°C±2°C
Temperature Coefficient of Voc	-0.25%/°C
Temperature Coefficient of Isc	0.04%/°C
Temperature Coefficient of Pmax	-0.34%/°C
Operational Temperature	-40°C~+85°C
Maximum System Voltage	1500VDC
Max Series Fuse Rating	20A
Limiting Reverse Current	20A

PACKAGING CONFIGURATION

	40ft(HQ)	20ft
Number of modules per container	936	180
Number of modules per pallet	36	36
Number of pallets per container	26	5
Box gross weight[kg]	805	805

CAUTION: READ SAFETY AND INSTALLATION INSTRUCTIONS BEFORE USING THE PRODUCT.

©2021 Risen Energy. All rights reserved. Contents included in this datasheet are subject to change without notice. No special undertaking or warranty for the suitability of special purpose or being installed in extraordinary surroundings is granted unless otherwise specifically committed by manufacturer in contract document.

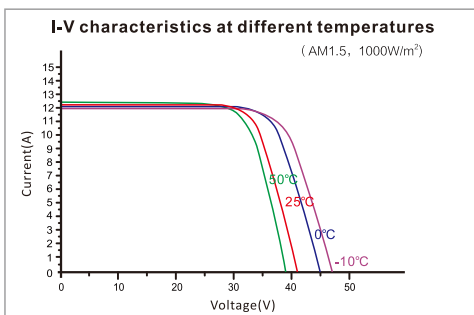
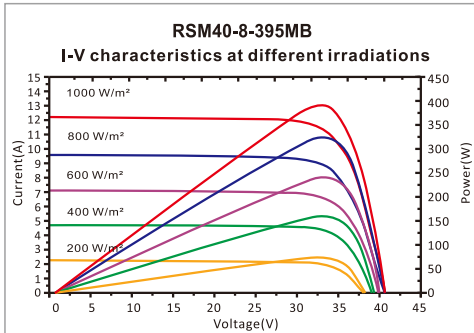

Our Partners:



RISEN ENERGY CO., LTD. (DOCUMENT)

RISEN ENERGY CO., LTD. (DOCUMENT)

RISEN PV MODULE INSTALLATION AND MAINTENANCE MANUAL

文件编号 DOCUMENT NO.	RS/03-MR-02-2021	编制 COMPILER	Xia dong
文件版本 EDITION	A/1[2022]	审核 REVIEWER	Pei shichao
分发编号 DISTRIBUTION NO.		批准 APPROVER	Liu Yafeng
受控状态 STATUS		东方日升新能源股份有限公司 盖章处 STAMP 受控文件	

THIS DOCUMENT HAS A TOTAL OF *41* PAGES INCLUDING THE FRONT COVER

发布日期 ISSUE DATE 2022-01-17 实施日期 IMPLEMENTATION DATE 2022-01-17

文件履历表

DESCRIPTION OF AMENDMENT

日期 DATE	版本 EDITION	章节 CHAPTER	修改内容摘要 AMENDED CONTENTS	记录人 RECORDER
2019.04	A/1	Chapter 8	Add 158.75 Cell module type; Update mounting hole position	Chen Shuilin
2019.06	A/2	Chapter 2,8,11	Add Added heterojunction module type, update the content	Chen Shuilin
2020.03	A/1[2020]	Chapter 3,4,8	Add RSMxxx-8 PV module model, Update the installation diagram, add the flat single shaft installation method, and delete some installation methods	Pei Shichao
2020.08	A/2[2020]	Chapter 7,8, 9	Add seaside installation requirements for module, installation method of flat single shaft, delete part of the models in the short side installation form, and add force requirements for the installation of connectors ,add RSM144-6 frame 25mm module load	Pei Shichao
2020.11	A/3[2020]	Chapter 1,7,8	Delete some PV module models、 update the requirements for seaside installation of salt spray-resistant modules、 change the expression of module models、 add RSM144-9、 RSM120-8 PV module	Pei Shichao
2021.03	A/1[2021]	Chapter 2,4,6, 7,8,9,12	Add the guidance of recycling and disposal of waste PV modules after quality assurance, cold shrinkable pipe fittings of salt spray-resistant modules and installation of double glass beams; Update bracket load, no beam load, add steel frame PV modules, 210 series PV modules, Single and double glass installation manuals are integrated	Chen shuilin
2021.06	A/2[2021]	Chapter 2,8	Add transparent backboard and 210 single glass PV modules; Add short side mounting mode ; Delete part of the installation mode; Add load data of PV modules matching with bracket;	Chen shuilin
2022.01	A/1[2022]	Chapter 4,7,8,9,11,12	Add load data of 210 single and double glass PV modules; Modify cleaning requirements of PV modules; Modify storage requirements of PV modules; Modify installation environment requirements of PV modules; Correct load data of 182 double glass PV modules; Add grounding and installation requirements of PV	Xia dong

东方日升新能源股份有限公司	PV module installation and maintenance manual	RISEN ENERGY CO.,LTD.
主导部门：组件研发中心		Page: NO.3 ,Total 41

			modules; Modify the description of module cable length and connection requirements;	

REQUIREMENTS: THIS DOCUMENT SHALL BE REVIEWED AND EVALUATED BY LEADING DEPARTMENT AT LEAST ONCE A YEAR, AND UPDATES SHALL BE MADE TO ENSURE THE PRACTICABILITY OF THE DOCUMENT WHEN IT IS NECESSARY.

DOCUMENT COUNTERSIGN

DEPARTMENT NAME	Group R&D Department	Quality and global customer service	Technical compliance	Global customer service	Quality management	Group Technology Integration Department					
COUNTERSIGNER	Liu yafeng	Jiang hongbo	Song Yifeng	Chen xiaoxu	Leng chuanquan	Xin xingliang					

东方日升新能源股份有限公司	PV module installation and maintenance manual	RISEN ENERGY CO.,LTD.
主导部门：组件研发中心		Page: NO. 4 , Total 41

PURPOSE

This manual provides a Risen Energy (Ninghai) new energy co., LTD. Risen Energy (Changzhou) new energy co., LTD. Risen Energy (Yiwu) new energy co., LTD. Risen Energy (Chuzhou) new energy co., LTD. Risen Energy (Malaysia) new energy co., LTD. (hereinafter referred to as Risen Energy or Risen), and recommends safe and reliable module installation and maintenance instructions for our customers.

Before installation, the installer must read and understand this manual. If you have any questions, please contact sales or customer service staff of Risen for further understanding. When installing, the installer shall comply with all safety precautions and installation laws and regulations in this manual. The installation personnel should be familiar with the mechanical load and electrical requirements of the installation system, and Risen has the right to refuse to compensate for the damage of the modules caused by the operation reasons or design defects of the power generation system.

SCOPE

This document applies to the installation of Risen Energy Co., Ltd.(including all factories) conventional single/dual glass modules .

OBLIGATIONS

PV Module R&D Center: responsible for the preparation, update and maintenance of this document.

东方日升新能源股份有限公司	PV module installation and maintenance manual	RISEN ENERGY CO.,LTD.
主导部门：组件研发中心		Page: NO.5 , Total 41

CATALOGUE

1.	Manual Introduction
2.	Applicable Products
3.	Warning.....
4.	Safety Cautions
5.	Unloading, Transportation and Storage.....
5.1.	Markers on outer packaging
5.2.	Unloading cautions
5.3.	Secondary transportation and Warning.....
5.4.	Storage.....
5.5.	Markings on module.....
6.	Matters needing attention for unpacking
7.	Installation
7.1.	Environment conditions and site selection
7.2.	Tilt angle of Installation
7.3.	Installation requirements for bifacial module
8.	Installation Guidelines
8.1	Bolting method for framed Bi-facial dual glass module.....
8.1.1	Bolts installation:
8.1.2	Fixture installation:
8.1.3	Offshore PV module connector protection device
8.2	Installation method of fixed support.....
8.3	Tracking system
9.	Cable layout.....
10.	Electrical Connection
10.1	Bypass secondary
11.	Grounding.....
12.	Inspection and Maintenance.....
12.1.	PV Module Recycling
12.2.	Module visual inspection and replacement.....
12.3.	Cleaning.....
13.	Troubleshooting
14.	DISCLAIMER.....

东方日升新能源股份有限公司	PV module installation and maintenance manual	RISEN ENERGY CO.,LTD.
主导部门：组件研发中心		Page: NO.6 , Total 41

1. Manual Introduction

Thanks for choosing Solar PV modules from Risen Energy Co., Ltd (hereinafter called Risen).

In order to ensure that the PV modules are installed correctly, please read the following installation manual carefully before modules are installed and used.

Please let the well trained professional to engage the PV module's installation, running and maintenance due to these works are based on the professional knowledge. The personnel for the installation should be familiar with the mechanical and electrical requirements.

Please get contact with Risen After-service Department (Afterservice@risenenergy.com) or Risen local agency if you want to get more details or there is any question.

2. Applicable Products

Risen's photovoltaic solar module is a DC power supply, which has the character of high reliability and nearly no-maintenance. It can be used in power systems of remote areas, home power systems, renewable energy vehicles, hydropower stations, water pumps, communication system or constitute solar photovoltaic power station directly. These systems not only can be used by battery, but also can be used by grid-connection directly without battery.

This document is applicable to the following PV Solar Modules types:

Monofacial modules	RSM60-6-xxxP/M	RSM72-6-xxxP/M	RSM120-6-xxxP/M	RSM144-6-xxxP/M
	RSM132-6-xxxP/M	RSM156-6-xxxP/M	RSM120-7-xxxP/M	RSM144-7-xxxP/M
	RSM120-6-xxxMB	RSM132-6-xxxMB	RSM144-6-xxxMB	RSM40-8-xxxP/M
	RSM40-8-xxxMB	RSM90-8-xxxP/M	RSM110-8-xxxP/M	RSM120-8-xxxP/M
	RSM132-8-xxxP/M	RSM150-8-xxxP/M	RSM144-9-xxxP/M	RSM60-6-xxx P/MDG
	RSM72-6-xxx P/MDG	RSM120-6-xxxP/MDG	RSM132-6-xxxP/MDG	RSM144-6-xxxP/MDG

Bifacial module	RSM60-6-xxx BMDG	RSM72-6-xxx BMDG	RSM120-6-xxx BMDG	RSM132-6-xxx BMDG
	RSM144-6-xxx BMDG	RSM120-7-xxxBMDG	RSM144-7-xxxBMDG	RSM90-8-xxxBMDG
	RSM110-8-xxxBMDG	RSM120-8-xxxBMDG	RSM132-8-xxxBMDG	RSM144-9-xxxBMDG
	RSM144-9-xxxBMDG	RSM150-8-xxxBMDG	RSM120-8-xxxBNDG	RSM144-7-xxxBMTG
	RSM60-6-xxx BHDG	RSM72-6-xxx BHDG	RSM120-6-xxx BHDG	RSM132-6-xxx BHDG
	RSM144-6-xxx BHDG	RSM156-6-xxx BHDG	RSM120-6-xxx HDGB	RSM132-6-xxx HDGB
	RSM144-6-xxx HDGB			

The detail parameter can be get from the official module datasheet from our website (www.risenenergy.com)

The Solar PV modules described in this manual are terrestrial used only, cannot be used in space. The high altitude influence to module operation should be considered when the modules are installed in high altitude area.。

3. Warning

Please read and understand all the safety cautions before the PV module installation, wiring, operation and maintenance. When exposed to the sun light or other light sources directly, the PV modules will generate the Direct Current, there will be the risk to cause people death when touching the electrical part like the connectors/terminals no matter whether the modules are connected or not

	<p>Maximum series fuse rating 20A Power production tolerance ±3% This module produces electricity when exposed to light. Follow all applicable safety precautions. Only qualified personnel should install or perform maintenance work on these modules Be aware of dangerous high DC voltage when connecting modules. Do not damage or scratch the rear surface of the modules. Do not handle or install modules when they are wet. Follow the battery manufacturer's recommendations if batteries are used with modules.</p>
---	--

4. Safety Cautions

In the installation and maintenance, all the Safety Cautions mentioned in this manuals should be followed, in the meantime, all the requirements defined by local law, authority agency or government should be followed.

Failed to follow this manual or the above rules/law will cause the fail of our Limited Warranty to the modules.

东方日升新能源股份有限公司	PV module installation and maintenance manual	RISEN ENERGY CO.,LTD.
主导部门：组件研发中心		Page: NO.8 , Total 41

- **Please get contact with local authority agency to confirm if the installation is legally allowed and meets the installation inspection requirements before installing the PV system.**
- **When designing the PV system, please be sure to consider about the voltage change under different temperatures (please check the temperature coefficients of all PV modules, when the temperature drops, the variable output voltage of the module will rise).**
- **The shading on the module surface will affect the power generation much, the module should be installed in the place where the module cannot be shadowed totally (such as the shadow from building, chimney and tree etc.), and even the partially shading (such as the dirt, snow and aerial wire etc.) should be avoided.**
- **The modules should be kept inside the original packaging before installation. In the transportation and storage period, please do NOT damage the packaging. The packaging cannot be opened unless at the installation site. It is recommended to open the packaging according to the opening procedure and handle this procedure carefully. It is forbidden to let the packaged module dropped directly.**
- **Please ensure the correct and proper method of transportation and installation, otherwise it could cause the module damage.**
- **The maximum limit of the stack layer is defined in the outer packaging carton box, please do NOT stack the modules more than this limit. Before opening the packaging, Please keep it in a ventilated, rainproof and dry place.**
- **It is prohibited to stand, climb, walk and jump on the unpacked packaging.**
- **To avoid damaging the module and to avoid affecting the module safety, please never put any heavy or sharp objects on the front and rear surface of the module at any time.**
- **When open the packing box, please use the professional and proper tools which can avoid the inclining and dropping of the module. It is forbidden to put the**

东方日升新能源股份有限公司	PV module installation and maintenance manual	RISEN ENERGY CO.,LTD.
主导部门：组件研发中心		Page: NO.9 , Total 41

module in a place without any supports or fixtures.

- **Never handle and move the module via the cable or the J-Box at any time. At least 2 personnel with non-slip gloves are required to handle one module at the same time. Do NOT carry the module via overhead and do NOT handle the stacked modules for moving.**
- **Please store the modules in a ventilated, rainproof and dry place when the temporary storage is needed.**
- **Please ensure all the modules and electrical contact parts are clean and dry in the installation.**
- **Do NOT install any module when it is raining, snowing and strong windy.**
- **Artificially concentrated sunlight shall NOT be directed on the module.**
- **Use durable, rust-resistant and UV-resistant materials to fabricate the module bracket structures which have been tested, certified and approved.**
- **When the modules were installed on the brackets, the brackets structure should have the ability to bear the wind load and snow load at site. And please ensure these load will not exceed the maximum load design of the module.**
- **The modules with the glass broken or the back-sheet damage cannot be repaired and CANNOT be used, there will be the electrical shock risk in case to touch the surface or frame of these kind of modules. Do NOT try to disassemble the module, and do NOT remove or damage the module nameplate and any other parts of the module.**
- **It is FORBIDDEN to stand on the modules in the installation progress, and do NOT damage or scratch the glass surface of the module.**
- **Do NOT apply any paint or glue to the module glass surface.**
- **The Solar PV modules will generate the electrical power when exposed to the sunlight, and this power is sufficient to cause fatal electrical shock and burning**

东方日升新能源股份有限公司	PV module installation and maintenance manual	RISEN ENERGY CO.,LTD.
主导部门：组件研发中心		Page: NO. 10 , Total 41

risk. Only the authorized personnel who is professional trained can close to the solar PV module.

- **To avoid the electrical shock and burning risk, the opaque material can be used to cover the modules in the installation.**
- **To avoid the electrical shock risk by damaged module, please do NOT wear metal objects such as ring, watch, ear ring and nose ring in the term of the installation and maintenance.**
- **Do NOT disconnect any electrical connections or unplug any connectors under circuit load.**
- **In order to prevent the degradation of the module insulation ability, please avoid scratching and cutting any cables or connectors.**
- **Use well insulated tools in accordance with relevant electrical installation standards. Keep children away from the installation site during transportation and assembly.**
- **Installation shall comply with local safety regulations (e.g., safety regulations, plant operation regulations), including wires and cables, connectors, charging controllers, inverters, batteries, rechargeable batteries, etc.**
- **Under the requirements of the NEC (National Electrical Code), the maximum system voltage shall not be higher than 1000V or 1500V. And the actual system voltage is specified on the nameplate of the module you are using.**
- **Under normal conditions, a mono-facial dual glass PV module is likely to experience conditions that produce more current and/ or voltage than reported at standard test conditions. The requirements of the National Electrical Code (NEC) in Article 690 shall be followed to address these increased outputs. In installations not under the requirements of the NEC, the values of Isc and Voc marked on this module should be multiplied by a factor of 1.25 when determining module voltage ratings, conductor ampacities, overcurrent device ratings, and size of controls connected**

东方日升新能源股份有限公司	PV module installation and maintenance manual	RISEN ENERGY CO.,LTD.
主导部门：组件研发中心		Page: NO.11 , Total 41

to the PV output; for bifacial dual glass module, additional factor of 1.1 should be multiplied at the same time.





- Risen Solar PV module is designed according to the IEC61215 and IEC61730, The application level is Class A, which can be used in systems operating at greater than 50 V DC or 240 W, where general contact access is anticipated, and Risen module also passed the IEC61730-1 and IEC61730-2, it meets the requirements of safety class II.
- Comply with electrical specification - part 1- electrical equipment safety standard CSA C22.1-12-2012.
- Modules with exposed conductive parts should be grounded according to the instructions in the installation manual and the electrical specifications required by local regulations, For use in regions or countries where UL1703 is required, it must comply with the requirements of the U.S. National Electrical Code or it will be considered a violation of UL1703. Please consult with local authorities for the requirements on installation methods and fire safety of buildings.
- Assess the fire rating of the system according to the condition of the roof and mounting brackets, subject to local electrical safety regulations. A suitable layer of fireproof material for this class shall be covered and the ventilation should be maintained.
- The difference of the roof structure and installation method will affect the fire safety performance, and unappropriated installation will take the risk to cause the fire. In order to ensure the fire rating of the roof, the minimum distance between the module frame and the roof surface is 100mm, the requirements to meet UL1703 region or country to use, modules on the surface of the frame and roof minimum distance is 115 mm , and appropriate modules such as fuses, circuit breakers and ground connectors should be used according to local electrical safety regulations.
- Observe the safety precautions of the module installation manual. If the modules are installed on the roof, ensure that the roof structure is reasonable. In addition,

the installation of any roof modules must be sealed to prevent leakage and to

- ensure the fire rating levels. The accumulation of dust on the modules surface will impair the performance of the modules. During the installation, the module tilt angle should be maintained at more than 10° to allow the rain to wash away the dust, while the module with too small tilt angle requires more frequent cleaning.
- Please do NOT operate any devices at the place where is closed to the flammable gas.

5. Unloading, Transportation and Storage

5.1. Markers on outer packaging

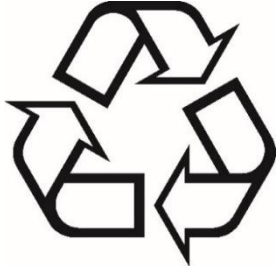
<p>Discarded at will of the module is forbidden and require special recycling</p> 	<p>Modules shall be kept dry, NOT exposing to the rain or moisture.</p> 	<p>Modules in carton are fragile, which shall be handled with care</p> 
<p>The number of stacking layers depends on the product packaging labels</p> 	<p>The packaging shall be transported upright.</p> 	<p>The packaging material can be recycled.</p> 

5.2. Unloading cautions

Use a suitable lifting fixture to handle, no more than 2 pallets of modules. Before lifting, check whether the tray and the carton are damaged and whether the hoisting ropes are strong and firm. Two people shall support at the two sides of the righting carton gently to place it on the relatively flat position of the project site

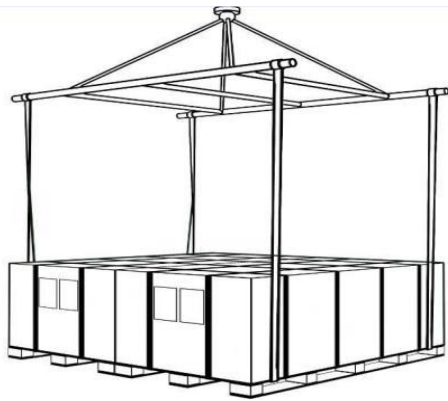

Use a forklift to remove the unit from the truck. During loading or unloading, the forklift must not hit the packing box.

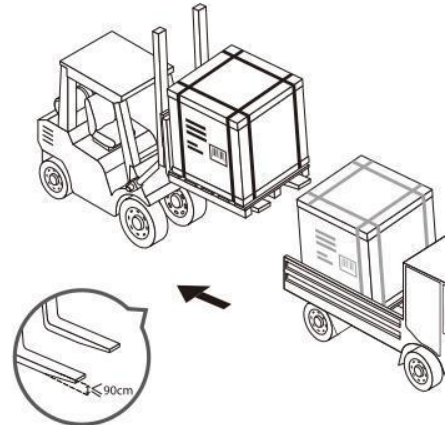

Place the modules on a level surface.

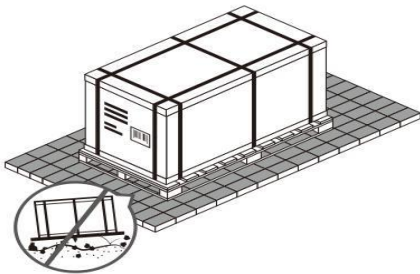

The stacking of modules at the project site is prohibited

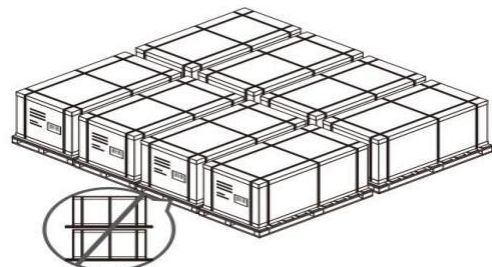

Place the unit in a dry and ventilated place.

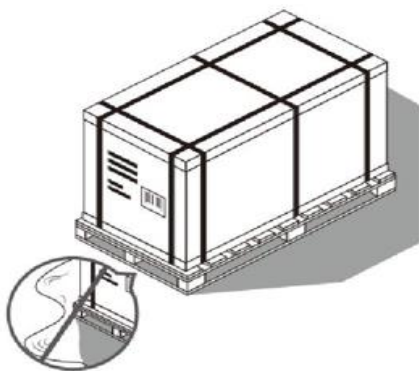

Cover the modules with a tarpaulin to prevent the package from getting wet.



5.3.Secondary transportation and Warning

Do NOT remove the original packages if the modules require long-distance transport or long-term storage.

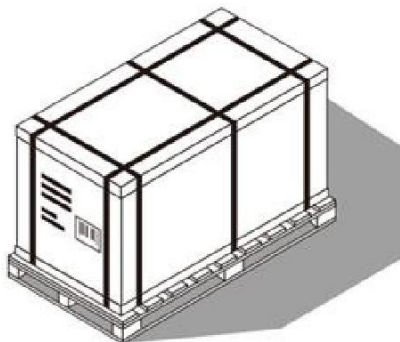

Packaged products can be shipped by land, sea, or air. During transportation, please fix the packing box on the transport platform to ensure that the packing will not roll over. No more than 2 layers by truck normally.

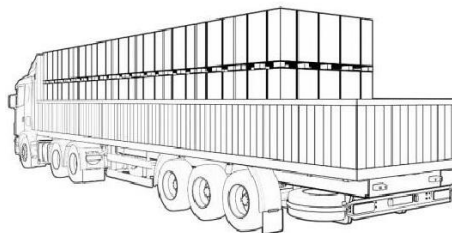

Please do not open the original packing when transferring the project to the destination. Please fix the packing box on the transportation platform to ensure that the packing box is firmly fixed.

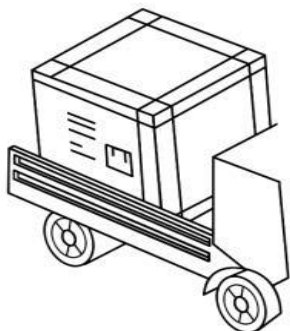

No Transportation of handling by pedicab as the following.

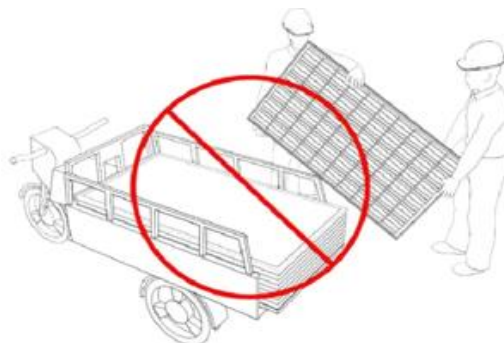

No handling the module with rope as the following.

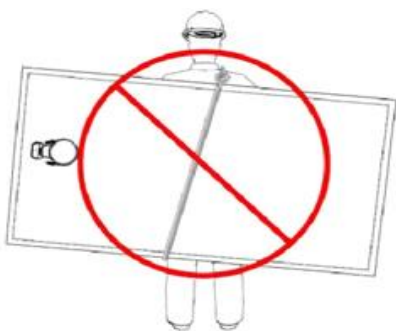

No carrying the module on the back of person



5.4. Storage

- Do NOT expose the modules to rain or moisture. Store the finished product in a ventilated, waterproof and dry place.
- Do NOT remove the original packaging if the module requires long-distance transport or long-term storage.
- Modules Stacking no more than 1 layers (moisture < 85%RH, temperature in the range from -40°C to + 50 °C) , see Fig. 5-1.



Fig. 5-1 temporary storage at site warehouse

5.5. Markings on module

Three markings are attached on the module with following information:

- Nameplate: module type, nominal power, rated current, rated voltage, Voc, Isc, certification logo and maximum system voltage, etc.
- Current marking: the classification according to the module's current.

To provide clear information of modules for customers to perform efficient installation, modules will be sorted according to three current classifications, which are as follow:

I1: Current Classification 1 I2: Current Classification 2

I3: Current Classification 3

- B: Unique bar code for each module. The bar code used by Risen includes 14 digits

东方日升新能源股份有限公司	PV module installation and maintenance manual	RISEN ENERGY CO.,LTD.
主导部门：组件研发中心		Page: NO. 16 , Total 41

or letters, and details are as follow. Set the YYMMDDABBCCCCC as the example:

- ✓ From the 1st to the 6th digits: YYMMDD means the manufacturing date;
- ✓ The 7th letter: A means Code for internal identification;
- ✓ The 8th and 9th digits: BB means the manufacturing workshop;
- ✓ From the 10th to the 14th digits: CCCCC means the serial number of production.

6. Matters needing attention for unpacking

- As for outdoors unpacking, it is prohibited to operate in rainy conditions. Because the carton will become soft and damaged after it gets wet in the rain. The PV modules (hereinafter referred to as "modules") inside the carton will incline, which may cause damage or injury to personnel.
- If there is wind at site, it is necessary to pay special attention to safety, especially in strong wind conditions, and it is NOT recommended to transport the modules at this situation. The unpacked modules shall be fixed properly.
- The ground should be flat where unpack the packaging, this will ensure that the carton can be placed stably and to avoid incline.
- Wear protective gloves during unpacking to avoid hand injury and finger prints on the glass surface.
- Module information and unpacking instructions can be found on the outer package. Please read the instructions before unpacking.
- Each module shall be handled by two personnel. It is forbidden to pull the wires or junction boxes of the modules to carry the module.

In addition to the above points for attention, consider professional on-site unpacking, exception handling rules, please refer to RISEN Packaging Manual.

东方日升新能源股份有限公司	PV module installation and maintenance manual	RISEN ENERGY CO.,LTD.
主导部门：组件研发中心		Page: NO. 17 , Total 41

7. Installation

7.1. Environment conditions and site selection

Risen module should be installed in the following environmental conditions.

Table 7-1 operation condition

NO	Environmental conditions	Range
1	Recommended Working temperature	-20°C to +50°C.
2	Extreme Working temperature	-40°C to +85°C
3	Humidity	< 85 RH%

Remarks: The working environment temperature is the monthly average maximum temperature and minimum temperature of the installation site. The mechanical load bearing capacity of the solar PV module is determined based on the installation method. The professional solar PV system installer must be responsible for calculating the solar PV system machinery when designing the solar PV system load bearing capacity.

- If the module will be installed in a place of which the humidity is more than 85RH%, please get contact with Risen After-service team (afterservice@risenenergy.com) for the properly installation method, or check whether the module can be installed or not.
- For most places, Risen solar PV modules should be installed where the sunlight can be maximally acquired throughout the year. In the Northern hemisphere, the light-receiving surface of the module is usually selected to face the South; in the Southern hemisphere, the light-receiving surface of the module is usually selected to face the North.
- When selecting the installation location, avoid areas with trees, buildings, or obstacles because these objects will form shadows on solar PV modules, especially when the sun is at the lowest position on the horizon in winter. The shadow will cause the loss of the output power of the solar photovoltaic system.

东方日升新能源股份有限公司	PV module installation and maintenance manual	RISEN ENERGY CO.,LTD.
主导部门：组件研发中心		Page: NO. 18 , Total 41

Although the bypass diode installed in the solar photovoltaic module can reduce this loss to some extent, do not ignore the shadow factor.

- Do not install solar PV modules near fire or flammable materials. In addition to floating projects or projects using coastal modules, do not install solar PV modules where there is water soaking, sprinkler or water spray.
- If the product needs to be used in the offshore environment *, please communicate with Risen technical team in advance to evaluate and use the coastal modules * of Risen.

Remarks: Offshore environment * refers to the environment within 1km of the straight-line distance Includes on the sea surface from the coastline; Coastal modules * can satisfy most coastal natural environments, but do not have absoluteness. Offshore installation may have additional impact on the performance and life of modules. If you need to install in the offshore environment, please evaluate and confirm with Risen technical team before purchase. If the modules are used in offshore environment projects without evaluation,Risen shall not be responsible for the failure of the modules due to environmental factors

7.2.Tilt angle of Installation

- The installation of solar PV module string should be in the same orientation and the same installation angle. Different installation directions and installation angles will lead to the mismatches in current and voltage which is caused by different light absorption of different solar modules, this mismatch will cause the PV system power output loss.
- The largest power will be generated When direct sunlight on solar PV module. For modules which are installed on the fixed brackets, the best installation angle should be selected to ensure the maximum power output can be generated at winter time, if the angle can guarantee enough power output during the winter, it will make the whole solar PV system in the rest of the year can have enough power output also.

- Installation inclination refers to the Angle between the solar photovoltaic module and the ground plane, as shown in Figure 7-1.

Fig. 7-1 Tilt angle

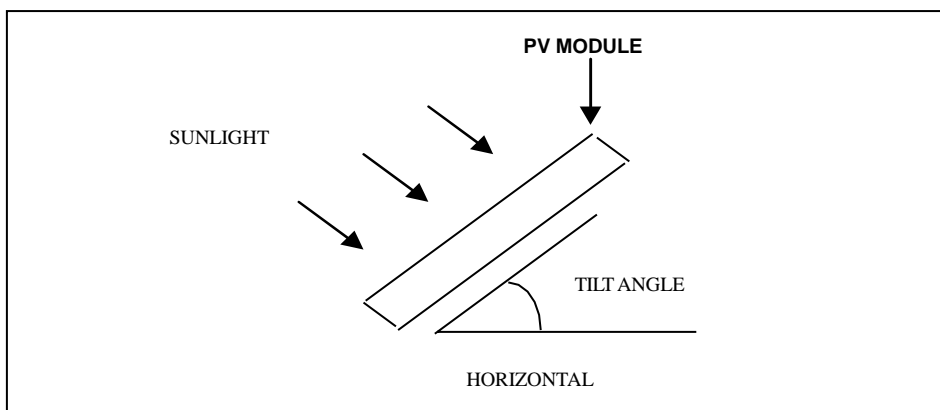

Table 7-2 Recommended tilt angle for fixed systems

latitude	Fixed angle of inclination
0°~15°	15°
15°~25°	The same latitude
25°~30°	Same latitude +5°
30°~35°	Same latitude +10°
35°~40°	Same latitude +15°
40°+	Same latitude +20°

7.3. Installation requirements for bifacial module

- Under the certain installation conditions, the backside of bifacial dual glass module will also generate electricity power after receiving the reflected light, which will bring additional power generation gain to the power station system.
- The shading on the module surface will affect the power generation much, the module should be installed in the place where the module cannot be shadowed totally (such as the shadow from building, chimney and tree etc.), and even the partially shading (such as the dirt, snow and aerial wire etc.) should be avoided.
- The generation gain is related to the ground reflectivity, the module installation height to the ground, the array spacing and the shadow shading to the module

backside.

- Generally speaking, the reflectance is various with the different ground (See table 7-3), and this will lead to different power generation gain.

Table 7-3 reflectivity of different surfaces

The ground type	Water	Grassland	Ground	Concrete	Sand	Snow
Reflectivity range (%)	5-12	12 - 25	20- 33	20 - 40	20 - 40	80- 85

- Due to the different ground clearance height will affect the power generation gain, it

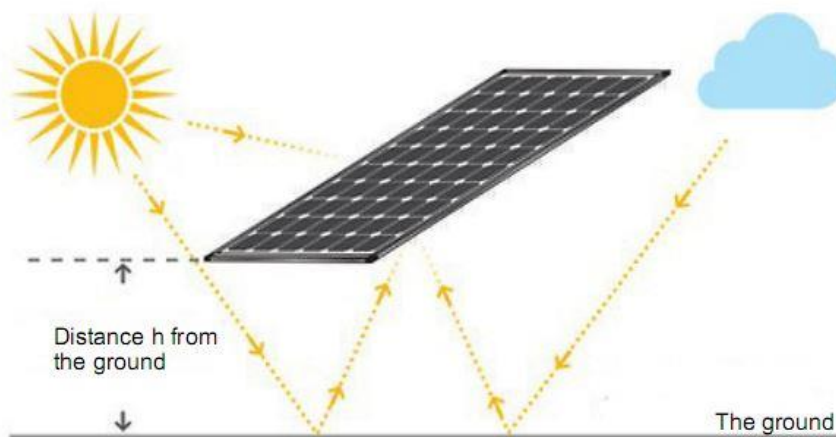

is recommended to install the module at a height from 0.5m to 2m. See Fig. 7-2.

Fig. 7-2 Distance from the earth

When designing the system, in addition to the type of ground and the height above the ground, the appropriate array spacing and how to avoid the back shadow should be considered. Please refer to 《Risen bifacial module PV system design white paper》, or consult professional system designers.

8. Installation Guidelines

- ✓ Ensure that the support system is strong enough and the modules must be fixed to the support system as required;

东方日升新能源股份有限公司	PV module installation and maintenance manual	RISEN ENERGY CO.,LTD.
主导部门：组件研发中心		Page: NO. 21 , Total 41

- ✓ The limit load of the support system must be calculated according to the project site conditions, installation methods, etc. and the local specifications. The support system supplier must be responsible for the design, verification, installation and maintenance of the photovoltaic system;
- ✓ In order to reduce the adaptation loss, please ensure that the modules with the same color cells to be installed together.
- ✓ The module frame has the effect of thermal expansion and cold contraction ,the minimum clearance between two adjacent modules must not be less than 10mm, for special requirements, please confirm with Risen technical team before installation.
- ✓ The module frame drain holes cannot be blocked in any situation during installation or use.
- ✓ PV modules are not suitable for long-term exposure to the environment containing sulfur, strong acid, strong alkali, acid rain, chemical pollution and other corrosion risk to the product, there is a risk of corrosion;
- ✓ Packaging angle bead and assembly safe edge play a protective role in packaging and transportation, which can be removed automatically when assembly is installed
- ✓ During installation of PV modules, shall not drag modules or rub surfaces;
- ✓ Installation of large size modules, the appearance of a certain degree of subsidence or deformation due to gravity is a normal phenomenon, after testing the appearance in line with the relevant standards
- ✓ All the load values below are the test load of laboratory static mechanical load experiment, and the actual design load of the project site needs to consider 1.5 times of safety factor.

The PV support system is generally divided into fixed installation system and tracker system. Risen PV module can be installed on two systems. The PV module and support system can be connected by bolts and clamp. Risen recommends some installation methods and accessories, as follows, please give priority. Other installation methods need to be confirmed with Risen.

8.1. Bolting method for framed Bi-facial dual glass module

8.1.1 Bolts installation:

- The Risen PV modules can be installed with bolts. There are mounting holes on the back frame of the PV module for connecting with the support system, including the mounting holes of ϕ 9x20 and ϕ 7x10. When using the ϕ 9x20 mounting hole, please use the M8 bolt set in table 8-1; when using the ϕ 7x10 mounting hole, please use the M6 bolt set in table 8-1, Flat washer outer ring size ≤ 16 mm.

Table 8-1 bolt set

Install the fasteners	M8 bolt set	M6 bolt set	Note
bolt	M8	M6	use corrosion resistant fasteners SUS304 is recommended
Flat washer	2*8	2*6	
Spring washer	8	6	
Nut	M8	M6	
Torque range	16N·m-20 N·m	14N·m-18 N·m	

8.1.2 Fixture installation:

- The Risen PV module can also be installed with clamp. The PV module shall be fixed on the mounting bracket with M8 bolts and clamp. It is strictly forbidden for the clamp to contact the front glass. The aluminum frame of the PV module shall not be deformed during installation, and the front of the module shall not be covered. Each PV module needs to be fixed with at least four clamp, and the applied torque is 16N · m ~ 20N · m.
- The size, quantity and installation method of the clamp can be determined according to the actual load of the project site, but it needs to meet the basic requirements in table 8-4 and be confirmed by the professional technical team of Risen.



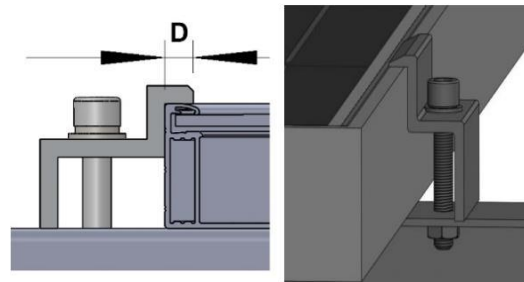
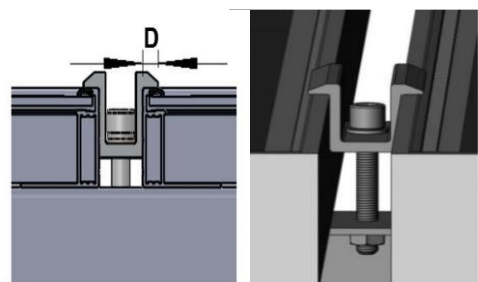



Table 8-2 clamp

Type	clamp	
	Side clamp	Middle clamp
Apply to aluminum frame assembly clamp		
Attention	Ensure that the clamp is in contact with the A side of the moduel frame by 7mm≤D ≤10mm;	
Specifications	clamp size: length≥50mm, thickness≥3mm,height of side clamp is consistent with the height of moduel frame;	
parts	M8 bolt 、 Nut、 Flat washer、 Spring washer、 clamp (To maximize support life, use of anti-corrosion firmware is recommended)	

8.1.3 Marine module connector protection device

- To install the modules on the offshore land and offshore sea less than 1km from the sea, the coastal modules with salt spray resistance of class 8 shall be installed, the annual rainfall hours/annual total hours are more than 25%, and the connectors on the offshore sea are recommended to install waterproof cold shrinkable tubes to prevent the connector from water inlet and corrosion; Silicone rubber is recommended for the material of cold shrinkable tube, Cold shrinkable tube from production to use before only half a year of validity, more than half a year without installation will not provide warranty.

表 8-3 Photovoltaic module connector accessories

Procedure	Method	Explanatory Chart
①	After unplugging the photovoltaic connector, take either end and cover the cold shrinkable tube to the connector in the direction shown on the right	
②	Slide the cold shrinkable tube over the head of the connecting head and expose the head	
③	Connect the positive and negative connectors in the correct way	
④	Move the connection to the middle of the cold shrinkable tube	
⑤	Pull the inner ring exposed in the cold shrinkable tube by hand, rotate and pull it out again and again until the inner ring is completely pulled out	
⑥	The cold shrinkable tube has completely cold shrinkable seal connectors	

● Notes for installation of cold shrinkable pipe:

- ① Before installation, make sure that there is no sand, water, sharp objects and other sundries inside the cold shrinkable tube.;
- ② It is forbidden to tie the label on the shrink tube to prevent the tie from scratching the shrink.;
- ③ Pay attention to environmental protection on site (handling of support strips/instructions/packaging bags);
- ④ There are no cracks or gaps at both ends of the cold shrinkable tube and no cracks on the surface;
- ⑤ The cold shrinkable tube should be affixed to the connector and cable in a natural way, and no wrinkle or bulge is allowed;

8.2.Installation method of fixed support

Table 8-4 Installation mode

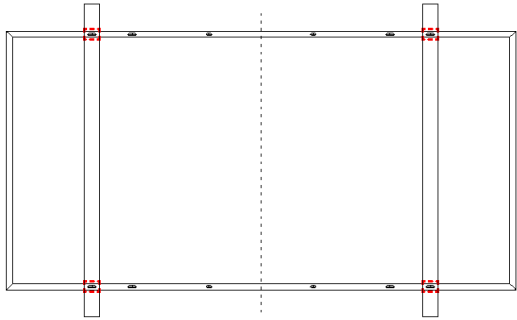

outer 4 holes installation with cross beam
(A1)

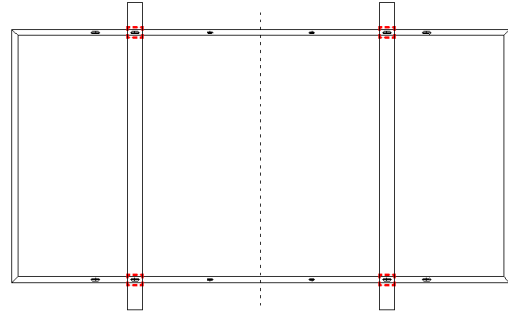

inner 4 holes installation with cross beam
(A2)

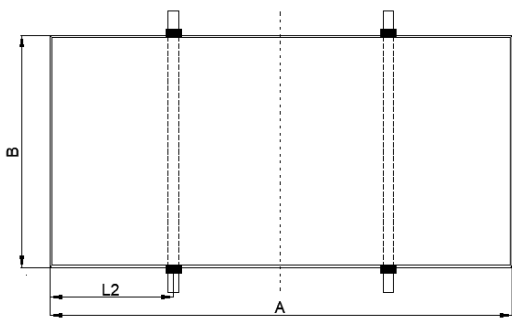

Clamp installation with cross beam
(A3) $(1/5A \leq L2 \leq 1/4A)$
Clamp size $\geq 50\text{mm}$

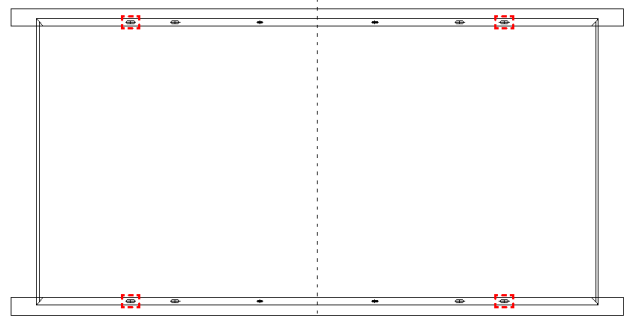

outer 4 holes installation without cross beam
(B1)

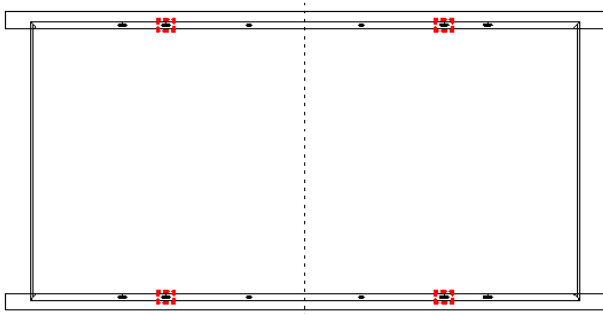

inner 4 holes installation without cross beam
(B2)

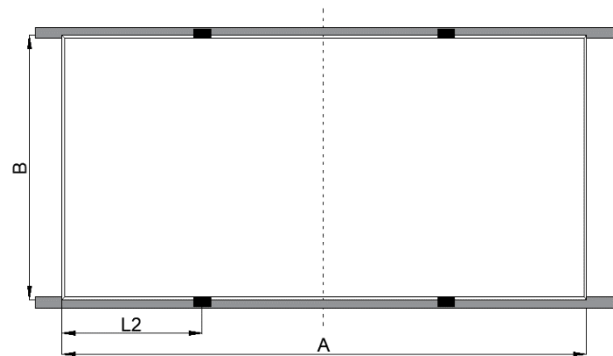

Clamp installation without cross beam
(B3) $(1/5A \leq L2 \leq 1/4A)$
Clamp size $\geq 50\text{mm}$

Table 8-5 Load values corresponding to installation methods

Installation		A2	A3	B2	B3
Module					
Monofacial module	RSM60-6-xxxP/M	+ 5400 -2400	+ 5400 -2400	/	/
	RSM72-6-xxxP/M	+ 5400 -2400	+ 5400 -2400	/	/
	RSM120-6-xxxP/M	+ 5400 -2400	+ 5400 -2400	/	/
	RSM132-6-xxxP/M	+ 5400 -2400	+ 5400 -2400	/	/
	RSM144-6-xxxP/M	+ 5400 -2400	+ 5400 -2400	/	/
	RSM156-6-xxxP/M	+ 5400 -2400	+ 5400 -2400	/	/
	RSM120-7-xxxP/M	+ 5400 -2400	+ 5400 -2400	/	/
	RSM144-7-xxxP/M	+ 5400 -2400	+ 5400 -2400	/	/
	RSM150-8-xxxP/M	+ 5400 -2400	+ 5400 -2400	/	/
	RSM120-6-xxxMB	+ 5400 -2400	+ 5400 -2400	/	/
	RSM132-6-xxxMB	+ 5400 -2400	+ 5400 -2400	/	/
	RSM144-6-xxxMB	+ 5400 -2400	+ 5400 -2400	/	/
	RSM60-6-xxxP/MD	+ 5400 -2400	+ 5400 -2400	/	/
	RSM72-6-xxxP/MD	+ 5400 -2400	+ 5400 -2400	/	/
	RSM120-6-xxxP/MD	+ 5400 -2400	+ 5400 -2400	/	/
	RSM132-6-xxxP/MD	+ 5400 -2400	+ 5400 -2400	/	/
	RSM144-6-xxxP/MD	+ 5400 -2400	+ 5400 -2400	/	/
	Bifacial module	RSM60-6-xxxBMDG	+ 5400 -2400	+ 5400 -2400	/
RSM72-6-xxxBMDG		+ 5400 -2400	+ 5400 -2400	/	+ 3600 -2400
RSM120-6-xxxBMD		+ 5400 -2400	+ 5400 -2400	/	+ 3600 -2400
RSM132-6-xxxBMD		+ 5400 -2400	+ 5400 -2400	/	+ 3600 -2400
RSM144-6-xxxBMD G		+ 3600 -2400	+ 3600 -2400	/	/
RSM144-6-xxxBMD G		+ 5400 -2400	+ 5400 -2400	/	+ 3600 -2400
RSM120-7-xxxBMD		+ 5400 -2400	+ 5400 -2400	/	+ 3600 -2400
RSM144-7-xxxBMD		+ 5400 -2400	+ 5400 -2400	/	+ 3600 -2400
RSM144-7-xxxBMT		+ 5400 -2400	+ 5400 -2400	+ 3600 -2400	+ 3600 -2400
RSM150-8-xxxBMD		+ 5400 -2400	+ 5400 -2400	+ 3600 -2400	/
RSM60-6-xxxBHDG		+ 5400 -2400	+ 5400 -2400	+ 3600 -2400	+ 3600 -2400
RSM72-6-xxxBHDG		+ 5400 -2400	+ 5400 -2400	+ 3600 -2400	+ 3600 -2400
RSM120-6-xxxBHD		+ 5400 -2400	+ 5400 -2400	+ 3600 -2400	+ 3600 -2400
RSM132-6-xxxBHD		+ 5400 -2400	+ 5400 -2400	+ 3600 -2400	+ 3600 -2400
RSM144-6-xxxBHD		+ 5400 -2400	+ 5400 -2400	+ 3600 -2400	+ 3600 -2400
RSM156-6-xxxBHD		+ 5400 -2400	+ 5400 -2400	+ 3600 -2400	+ 3600 -2400

Table 8-6 Load values corresponding to installation methods

Module		Installation	A1	A3	B1	B3
Monofacial module	RSM40-8-xxxP/M		/	+ 5400 -2400	/	/
	RSM110-8-xxxP/M		+ 5400 -2400	+ 5400 -2400	/	/
	RSM120-8-xxxP/M		+ 5400 -2400	+ 5400 -2400	/	/
	RSM132-8-xxxP/M		+ 5400 -2400	+ 5400 -2400	/	/
	RSM144-9-xxxP/M			+ 5400 -2400	/	/
	RSM40-8-xxxMB		/	+ 5400 -2400	/	/
Bifacial module	RSM90-8-xxxBMDG		/	+ 5400 -2400	/	/
	RSM110-8-xxxBMD		+ 5400 -2400	+ 5400 -2400	/	+ 3600 -2400
	RSM120-8-xxxBMD		+ 5400 -2400	+ 5400 -2400	/	/
	RSM120-8-xxxBNDG		/	+ 5400 -2400	/	+ 5400 -2400
	RSM132-8-xxxBMD		/	+ 5400 -2400	+ 3600 -2400	/
	RSM144-9-xxxBMD		+ 5400 -2400	+ 5400 -2400	+ 3600 -2400	/

Table 8-7 short side installation diagram of PV modules

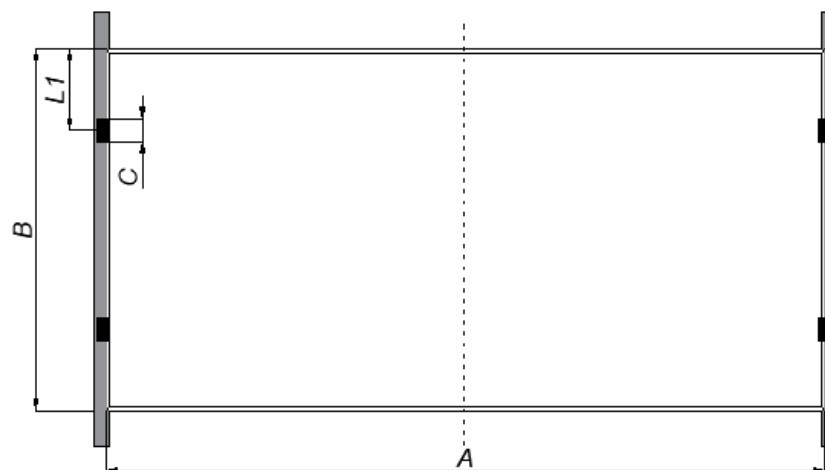

Module	L1	Load test
RSM60-6-P/M、RSM120-6-P/M RSM60-6-PDG/BMDG、 RSM120-6-PDG/BMDG RSM120-7-P/M、RSM120-7-BMDG RSM40-8-P/M、RSM40-8-xxxMB	25mm≤L1≤1/4B	front≤1800pa back≤1200pa

● Risen Energy does not recommend the installation of double-sided modules with short side

pressing blocks. When the short side is installed, the support point of the module is far away. Under the weight of the module or the action of a small load, there will be a slight deformation in the middle of the module, which is elastic deformation. After the module is removed or the load is removed, it can be restored to its original state without causing the battery crack and power attenuation. However, it is easy to increase the amount of ash, which requires frequent cleaning of the surface of modules

- In severe environment such as snowstorm, when the modules are subjected to heavy snow load, the central part will produce large shape variables, which will affect the appearance of the modules. In the process of module deformation, if the junction box or glass is in contact with the obstacles below, the glass on the back will produce a large stress, and the module will have the risk of rupture. The distance between the obstacles below the module and the junction box or glass is required to be more than 120mm by day rise.
- When installing with short side pressing block, load calculation and support structure design shall be carried out by professional structural engineers according to the project climate conditions, and foreign bodies under the positive projection of the module glass shall be avoided. The appearance caused by dead weight or other loads shall not be considered as defects and shall not be within the scope of warranty.

1.1 Tracking system

Risen PV modules can be installed on the tracking system, and the installation hole should be selected according to the design form of the tracker.

Table 8-8 Installation mode of tracking system

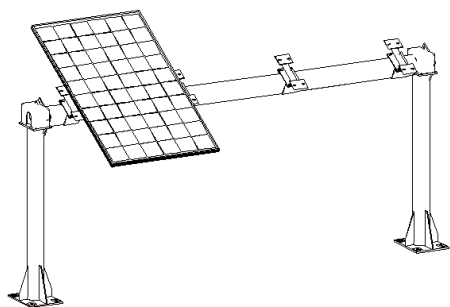

1P installation mode

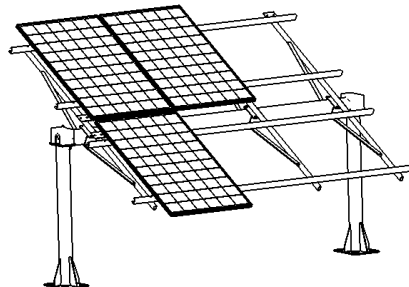

2P installation mode

 <p>C1 400mm pitch hole installation</p>	 <p>C2 400mm pitch hole + inner four hole installation</p>
 <p>C3 400mm pitch hole + outer four hole installation</p>	<p>Risen module can be installed and used on the tracking system, and the installation hole position or clamp position shall be selected according to the design of the support system. Please refer to section Table 8-9 for details;</p> <p>The system installer or professional designer shall recheck the bearing capacity of the support system (photovoltaic support, foundation, etc.) according to the selected installation hole position or pressing block position.</p>

Table 8-9 List of Risen module loads with tracking system

Classification	Installation Module	NEXTracker NX Horizon			ATI DuraTrack™HZ Tracking System				Arctech solar installation bracket		
		Short rail	Short rail +bumper	Short rail + supplement rail	400 mm clamp	600 mm clamp	850 mm clamp	1300 mm clamp	C1	C2	C3
Monofacial module	RSM72-6-xxxP/M DG	±2400	±3000	/	±1800	±2400	+3000 -2400	+3600 -2400	/	/	/
	RSM144-6-xxxP/M	±1600	/	/	±1600	±1600	/	/	/	/	/
	RSM144-6-xxxP/MDG	±2400	±3000	/	±1800	±2400	+3000 -2400	+3600 -2400	/	/	/
	RSM144-6-xxxM B	±1600	/	/	±1600	±1600	/	/	/	/	/
	RSM156-6-xxxP/M	±1600	/	/	±1600	±1600	/	/	/	/	/
	RSM120-7-xxxP/M	±1600	/	/	±1600	±1600	/	/	/	/	/
	RSM144-7-xxxP/M	±1600	/	/	±1600	±1600	/	/	/	/	/

Bifacial module	RSM110-8-xxxP/M	+1200 -1000	/	/	±1600	±2400	±2600	±2800	/	/	/
	RSM120-8-xxxP/M	+1400 -1200	/	/	±1600	±1800	±2000	±2400	/	/	/
	RSM150-8-xxxP/M	±2400	±3000	/	±1600	±2400	/	/	/	/	/
	RSM72-6-xxxBM DG	±2400	±3000	/	±1800	±2400	+3000 -2400	+3600 -2400	/	/	/
	RSM72-6-xxxBH DG	±2400	±3000	/	±1800	±2400	+3000 -2400	+3600 -2400	/	/	/
	RSM144-6-xxxB MDG	±2400	±3000	/	±1800	±2400	+3000 -2400	+3600 -2400	/	/	/
	RSM144-6-xxxBH DG	±2400	±3000	/	±1800	±2400	+3000 -2400	+3600 -2400	/	/	/
	RSM144-7-xxxB MDG	±2400	±3000	/	±1800	±2400	+3000 -2400	+3600 -2400	/	/	/
	RSM150-8-xxxB MDG	±2400	±3000	/	±1800	±2400	+3000 -2400	+3600 -2400	/	/	/
	RSM156-6-xxxBH DG	±2400	±3000	/	±1800	±2400	+3000 -2400	+3600 -2400	/	/	/
	RSM144-9-xxxB MDG	±2000	/	/	±1200	±1200	+3000 -2400	+3600 -2400	/	/	/
	RSM110-8-xxxB MDG	+1600 -1400	/	/	+1600 -1400	+1600 -1400	+2000 -1800	+2400 -2000	±1600	+2400 -2200	+3000 -2400
	RSM120-8-xxxB MDG	+1600 -1400	/	/	+1600 -1400	+2000 -1600	+2400 -2000	+2400 -2000	±1600	+2400 -2200	+3000 -2400
RSM156-6-xxxBH DG	±2400	±3000	/	±1800	±2400	+3000 -2400	+3600 -2400	/	/	/	

9. Cable layout

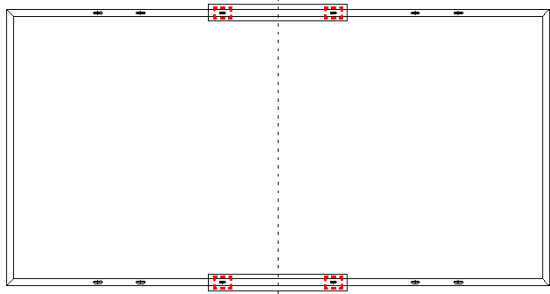
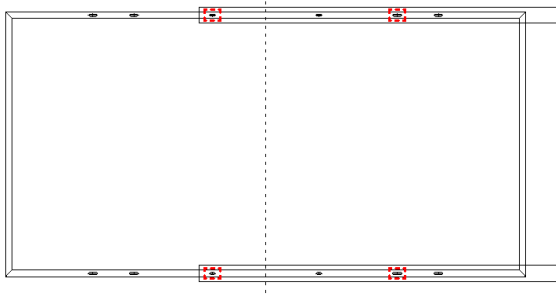
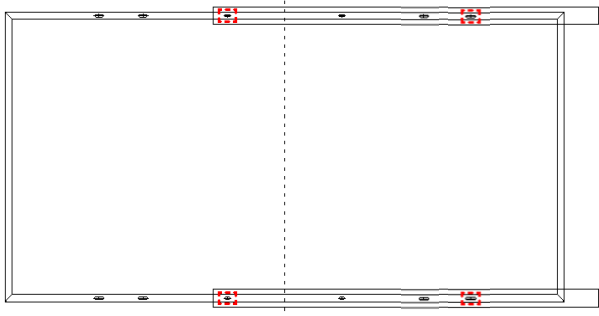
- Cable Length: Half-piece assembly cable are divided into short cables and long cables
- The recommended vertical installation connection methods for module with short cables. See Fig. 9-1. The horizontal installation connection methods see Fig. 9-2.
- When install modules with long cables, connect it with its own cable length and do not use extended cables, see Fig. 9-3 and 9-4, When connect adjacent modules in different rows or columns, connect cables on the same side and avoid connecting cables along the diagonal line.

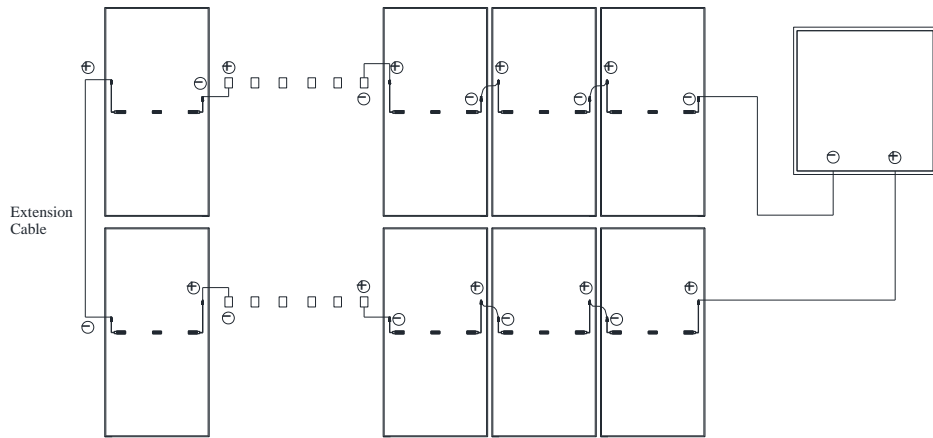

Fig. 9-1 Vertical installation of short cable modules

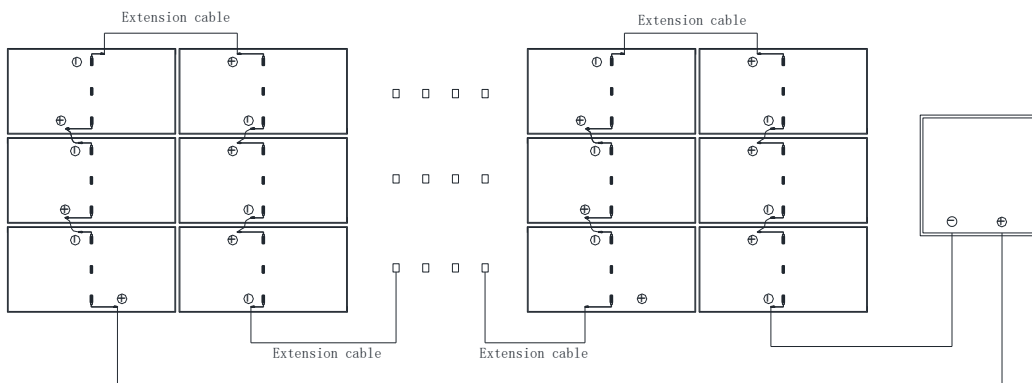

Fig. 9-2 Horizontal installation of short cable modules

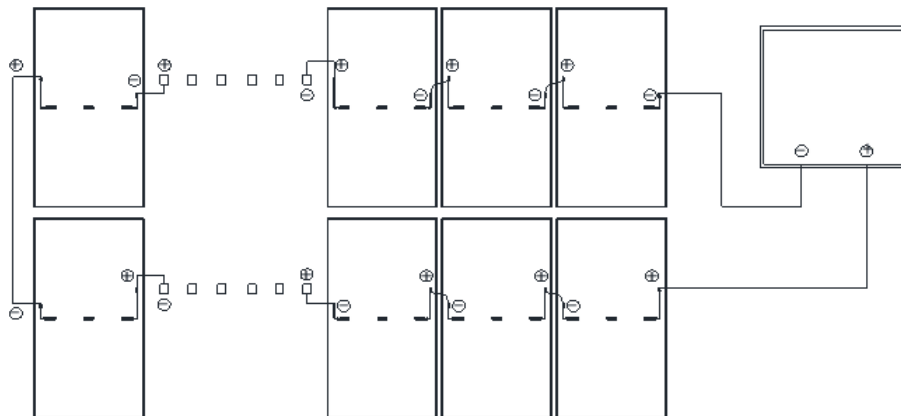

Fig. 9-3 Vertical installation of long cable modules

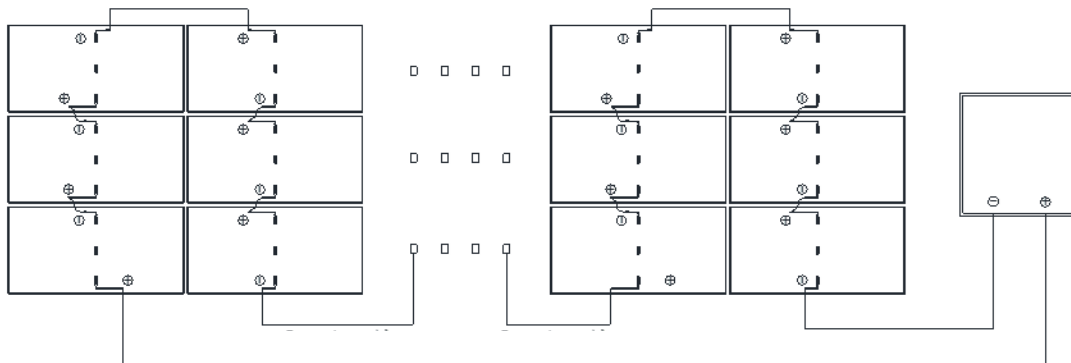

Fig. 9-4 Horizontal installation of long cable modules

Precautions:

1. Pay attention to the direction of the wire when installing the modules. It should be connected along the wire direction to avoid bending the wire.

2. In order to avoid bad or damaged connection of the cable and connector, the cable and junction box caused by human factors, affecting the electrical safety or service life of the product, it is recommended that the force applied between the cable and connector, cable and junction box shall not be greater than 60N during the installation, dismantling, maintenance and any other related process of the Product

10. Electrical Connection

- The Direct Current (DC) generated by the PV system can be converted to Alternating Current (AC) and connected to the public power grid. Different regions may have different policies, laws and regulations to stipulate the installation and grid-connection requirements of PV systems. Therefore, during the design, installation and grid-connection of PV system, please comply with the local policies, laws and regulations.
- PV modules can obtain different current and voltage outputs through series connection and parallel connection. Read this installation manual carefully before electrical connection and installation. Please design and connect according to the current and voltage required by customers. Before connection, please ensure that the connection part is free from corrosion, and keep it clean and dry.

- In order to ensure the normal running of the system, when connecting modules or loads, please ensure that the polarity of the cable connection is correct. If the modules are incorrectly connected, the bypass diodes and junction boxes may be damaged. PV modules can be connected in series (Fig. 10-1), in parallel (Fig.10-2) and in series-parallel (Fig. 10-3). The number of serial or parallel connections shall be reasonably designed according to the system configuration. Also note that if the number of parallel connections ≥ 2 , there must be an over-current protection device on each string assembly.

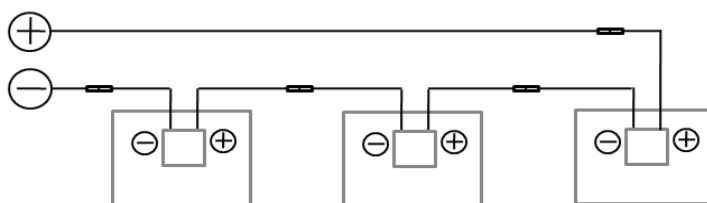

Fig. 10-1 Series Connection

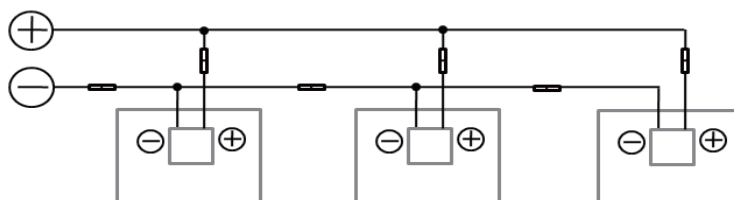

Fig.10-2 Parallel Connection

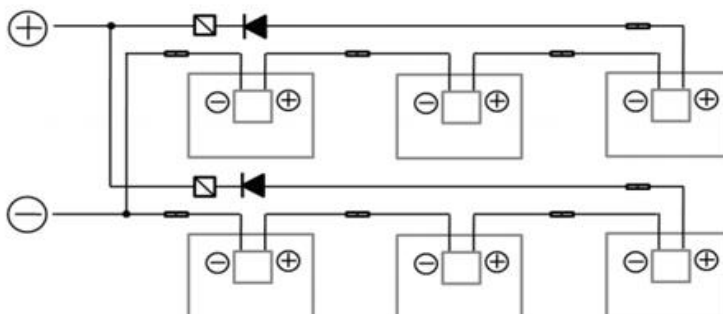

Fig.10-3 Parallel-series Connection

- Different types of modules cannot be connected in series. Modules connected in series should ensure the consistency of their current. The voltage of the module string should not exceed the allowable system voltage value, which can be found on

the nameplate or datasheet of the module.

- The maximum number of modules in series depends on the system design, the type of converter used and the environmental conditions. In general, the maximum number (N) of PV modules in series can be calculated by dividing the maximum system voltage by the open circuit voltage of the relevant solar PV modules. When designing the solar PV system, it is necessary to take into account the characteristic that the voltage of the solar PV module changes with the temperature. Considering the voltage increase caused by temperature drop in extreme environment in winter, the maximum series connection number of solar PV modules can be calculated by the following formula.

Table 10-1 maximum series connection number calculation

Formula	Maximum system voltage $V \geq N \times V_{oc} \times [1 + \beta \times (T_{min} - 25)]$
V	Maximum system voltage
N	The number of maximum solar PV modules in series
V_{oc}	The open circuit voltage of each module (see product label or data sheet)
β	Temperature coefficient of open circuit voltage of the module (refer to data sheet)
T_{min}	The lowest ambient temperature at installation site

Remarks: if the number of parallel connections is greater than or equal to 2, there must be an over-current protection device on each string of modules.

- Product can be irreparably damaged if an array string is connected in reverse polarity to another. Always verify the voltage and polarity of each individual string before making a parallel connection. If you measure a reversed polarity or a difference of more than 10V between strings then check the string configuration before making the connection.
- Before wiring the module, ensure that the contact points are corrosion resistant, clean and dry; If a string of modules is reversed, irreparable damage can be caused
- For relatively large installations, nison recommends that you use lightning protection in accordance with local requirements and regulations.
- Each Risen solar PV module has two PV cables which can withstand 90 °C

东方日升新能源股份有限公司	PV module installation and maintenance manual	RISEN ENERGY CO.,LTD.
主导部门: 组件研发中心		Page: NO. 35 , Total 41

temperature and they are sunlight resistant(UV). The cross-sectional area of the cable is 4mm² or 12AWG, and the external diameter is 4mm-7mm. Plug & Play connectors are included at the end of each cable. All other cables used to connect the direct current system shall have similar (or higher) specifications, and should have the suitable insulation ability which can suffer the possible maximum system Voc (as defined in TUV 2PFG1169 or EN50618 (H1Z2Z2-K)). Risen requires all cables and electrical connections to comply with the electrical regulations of the countries where the PV system is installed.

- When selecting a cable, the minimum current-carrying capacity of the cable can be calculated by the following formula.

Minimum current-carrying capacity of the cable = 1.25 x I_{sc} x N_p

I_{sc}: short-circuit current of PV module (unit: A)

N_p: the number of modules in parallel or module strings

- To clear or trim excess cables and Risen recommends that all cables be placed in proper pipework and away from standing water.
- Risen recommends using lightning protection devices which are complied with local laws and electrical regulations

10.1 Bypass secondary

- If solar photovoltaic module part by shadow block, which can lead to reverse voltage related to solar cells, solar photovoltaic modules in other unaffected battery string or other solar PV modules in the system and current will force through keep out part of the power loss and heat affected cell. When the solar photovoltaic module is connected in parallel with the bypass diode, the current in the system will flow directly through the diode, so as to bypass the blocked part of the solar photovoltaic module and minimize the heating degree and power consumption of the solar photovoltaic module.
- Each module has three diodes. Each module has three diodes. Diode model, such as 20 sq045 / SBRB2045S SMBRB3045S /GF2045MG /SBRB3050TS /MSB3050T3A/

东方日升新能源股份有限公司	PV module installation and maintenance manual	RISEN ENERGY CO.,LTD.
主导部门: 组件研发中心		Page: NO. 36 , Total 41

MSB3050T3B (Twinsel PV junction box - SY001 / PV - SY005 / PV - SY015 / PV - RS006 / PV - SY017). Please do not try to open the junction box to replace the diode, or even when the diode problem, please do this work by professionals

11. Grounding

- **All solar PV module frames and mounting bracket must be properly grounded in accordance with the appropriate National Electrical Code or local electrical codes**
- **Correct grounding is achieved by continuously connecting the PV module frame and all metal modules together using the appropriate grounding conductor. The grounding wire may be copper, copper alloy or other materials that can be used as conductors and meet the requirements of the national electrical code. It is recommended to use the copper wire (4-14 mm² or AWG 6- 12) as the grounding wire. The signal “” can be found at the grounding hole position. The ground wire must also be connected to ground through a suitable ground electrode. The tight connection of all the joint point should be ensured.**
- **On a grounding hole with a diameter of $\phi 4$ mm, use a separate grounding wire and related accessories to connect the frame and connect the grounding wire to the ground. M4 x 12mm ground bolts with M4 nuts, star washers and plain washers are recommended for the aluminum frame, M4 tapping locking screws or ST4.2 tapping screws are recommended for high-strength alloy steel frames, see fig.11.2, this ensures that the modules are firmly grounded. You can find the corresponding product drawing in module datasheet to know the detailed number, size and position of the grounding holes. The torque applied to ground fixation is 4N· m~8N ·m.**

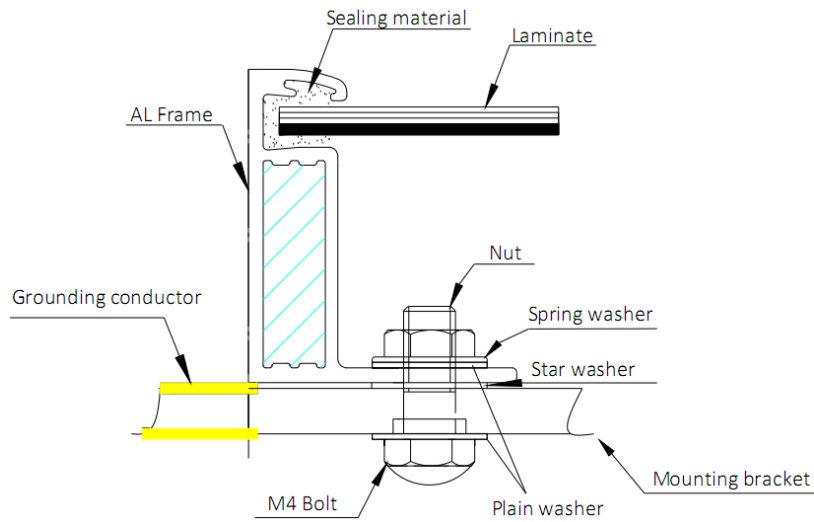

Fig. 11.1 M4 Bolt grounding

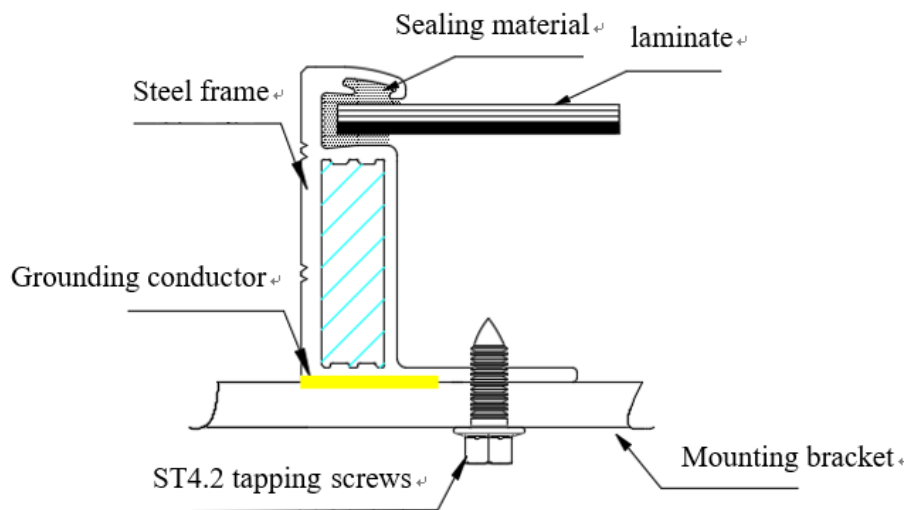

Fig.11.2 ST4.2 tapping screws grounding

In addition to use the grounding hole, you can also choose the following grounding ways:

- ✓ Grounding by unused mounting holes
- ✓ Other professional grounding devices

No matter which grounding method is adopted, all conductive connections to the frame of PV module frame should penetrate the insulation layer to ensure the reliability of grounding. Risen modules can be grounded by other grounding devices, which must be reliable and certified. The manufacturer's requirements

东方日升新能源股份有限公司	PV module installation and maintenance manual	RISEN ENERGY CO.,LTD.
主导部门：组件研发中心		Page: NO. 38 , Total 41

should be followed.

12. Inspection and Maintenance

In order to ensure the long-term using of the installed PV system and maximize the Power output performance of the modules, the installed PV modules need to be inspected and maintained regularly. The inspection and maintenance of modules in the PV array shall be carried out by personnel who have received professional PV system maintenance training and obtained relevant qualifications and authorization.

12.1.PV Module Recycling

- PV module that that cannot be used due to a malfunction should be deactivated. You can dispose of these dead modules in the following ways:
 - ✓ Please consult and follow the local laws and regulations, must have a qualified institution to recover processing, the product disposal;
 - ✓ If your area is covered by a PV Cycle specialist, you can contact them directly for processing.

12.2.Module visual inspection and replacement

- The PV modules installed in the PV array should be inspected periodically for damage. If functional and safety faults are found due to the following factors, the modules of the same type should be replaced immediately.
 - ✓ PV modules have broken glass, scratched back sheet.
 - ✓ Bubbles or delamination form a continuous path between electric circuit and the edge of the module.
 - ✓ Junction box is deformed, cracked or burned, and the terminals cannot be connected well.
- Replace failed PV modules with same type. Do not touch live wires and connectors directly. When you need to touch them, use suitable safety devices (insulation tools/gloves, etc.).
- The warning signs on the PV modules must not be lost.

东方日升新能源股份有限公司	PV module installation and maintenance manual	RISEN ENERGY CO.,LTD.
主导部门: 组件研发中心		Page: NO. 39 , Total 41

- **Check the electrical, grounding and mechanical connections every 6 months to ensure they are clean and safe, free from damage or rust. Check that the mounting parts are tight. Check all cables and make sure that the connectors are securely. PV modules frames and bracket should be well mechanically connected.**
- **Check whether there is any foreign body on the surface of the PV modules and whether there is any shielding.**
- **When repairing PV modules, cover the surface of PV modules with opaque material to prevent electric shock. Exposure of PV modules to sunlight will generate high voltages, this is dangerous. Please pay attention to safety when maintenance and it must be done by professionals.**
- **When the irradiance is no less than 200W/m², if the terminal voltage is more than 5% different than the rated value, it illustrates the connection of the modules is not good.**
- **Comply with maintenance instructions for all modules used in the PV system, such as brackets, charging rectifiers, inverters, batteries, lightning protection systems, etc.**
- **Warning: Any electrical maintenance must shut down the PV system firstly. Improper system maintenance may cause fatal dangers such as electric shock and burning.**

12.3.Cleaning

- **Dust accumulation on the glass surface of the module will reduce its power output and may cause hot spots. So the surface of photovoltaic modules should be kept clean. Maintenance work should be performed at least once a year or frequently.**
- **Warning: It should be carried out by trained personnel. Workers should wear PPE, such as goggles, electric insulation gloves and safety shoes. The gloves should withstand DC voltages of no less than 2000V**

东方日升新能源股份有限公司	PV module installation and maintenance manual	RISEN ENERGY CO.,LTD.
主导部门：组件研发中心		Page: NO. 40 , Total 41

- **Use dry or wet soft cloths, sponges, etc. to clean the modules during the cleaning process, but do not put any modules directly into the water, do not use corrosive solvents and do not wipe the PV modules with hard objects. When the pressure water is used, the water pressure on the glass surface of the module must not exceed 700 KPa. The module must not be subjected to additional external force. If necessary, use isopropyl alcohol (IPA) according to the safety instructions to clean and ensure that no IPA flows into the gap between the edge of the module and the module frame.**
- **To reduce potential electric shocks or burns, suggest cleaning the PV modules in the early morning or evening when the sunlight is weak and the temperature is low, especially for areas with higher temperatures.**
- **It is forbidden to clean photovoltaic modules under weather conditions with heavy rain, heavy snow or winds greater than class 4.**
- **The back surface of the module normally does not need to be cleaned, but in the event this is deemed necessary, avoid the use of any sharp objects that might damage or penetrating the substrate material.**
- **Water requirements when cleaning:**
 - ✓ PH: 5~7;
 - ✓ Chloride or salt content: 0 - 3,000 mg/L
 - ✓ Turbidity: 0-30 NTU
 - ✓ Conductivity: 1500~3000 μ s/cm
 - ✓ Total dissolved solids: \leq 1000 mg/L
 - ✓ Water hardness: 0-40 mg/L
 - ✓ Non-alkaline water must be used, and softened water can be used when conditions permitted.
- **Module inspection after cleaning**
 - ✓ Visual inspection to check if the module is clean, bright and free of stains;

东方日升新能源股份有限公司	PV module installation and maintenance manual	RISEN ENERGY CO.,LTD.
主导部门：组件研发中心		Page: NO. 41 , Total 41

- ✓ Spot check to verify whether there is soot deposit on the module surface;
- ✓ Check to whether there are visible scratches on the surface of the module or not;
- ✓ Check whether there is no man-made cracks on the module surface or not;
- ✓ Check whether the module support structure is leaning or bent or not;
- ✓ Check whether the connectors of the module are detached or not, After cleaning, fill out the PV module cleaning record.

13. Troubleshooting

- If the PV system does not work properly, please inform your installer immediately. It is recommended to perform a preventive inspection every six months, please don't change any modules of the modules. If electrical or mechanical properties are required for inspection or maintenance, qualified professionals should be advised to avoid any electric shock or loss of life.

14. DISCLAIMER

- Risen is not responsible for any form of damage, including but not limited to module operation and system installation error, and personnel injury, hurt, and property loss resulted from failure to follow the instructions in this Manual.
- Failure of the customer to follow the requirements outlined in this Manual during the installation of the module will result in the invalidity of product's limited warranty.
- Risen is not responsible for any infringement of third party patents or any other rights arising from the use of solar PV modules.
- Risen reserves the rights to change this Manual without prior notice.
- The information in this Manual is derived from knowledge and experience, and such information and recommendations do not constitute any warranty.

This Manual is available in electronic form only. Please call our customer service hotline (400-8291-000) if you need a hard copy. In case of any discrepancy between the Chinese and English versions of this Manual, the Chinese version shall prevail. Risen reserves the rights to interpret this Manual.